

## Standard Profiles

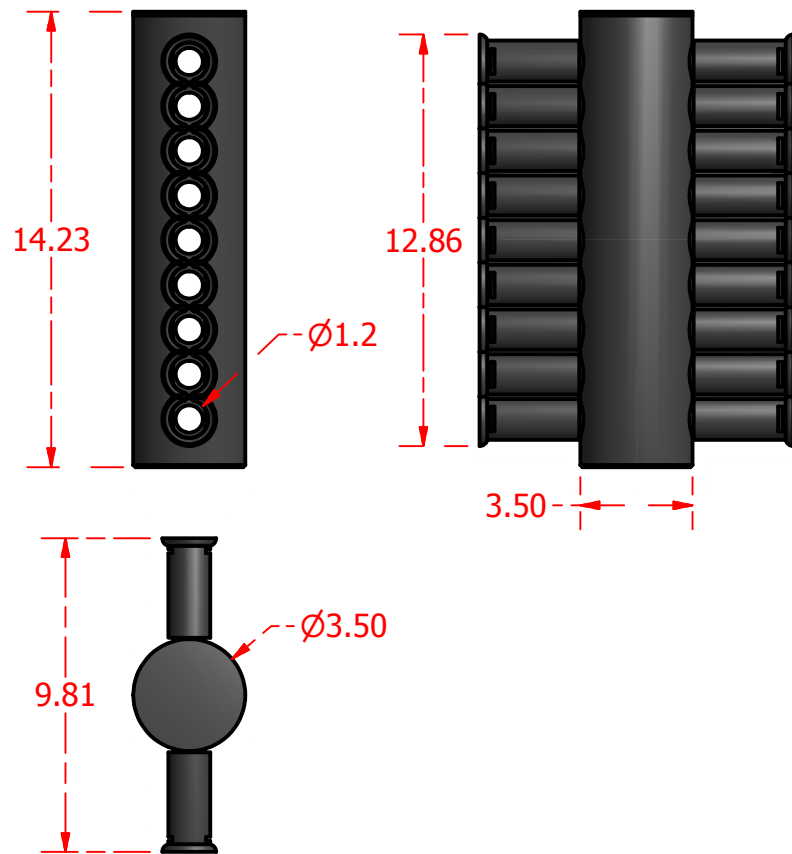

## Isometric Views

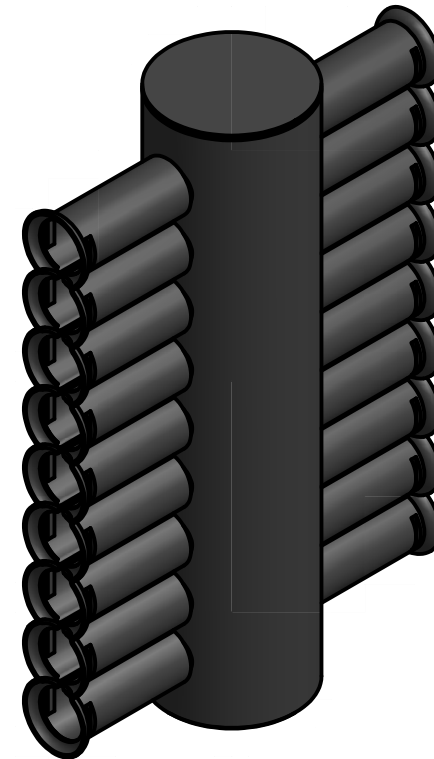

## Multi-Flow Product Data Sheet - #12009 Multi-Purpose 12" to 12" Coupler



Manufactured by Varicore Technologies, Inc. - Prinsburg, MN 56281 - 800.978.8007

The Multi-Flow logo is Copyright protected, all rights reserved.

US Patent Protect - 9483745856834

### PROPERTY

Material Composition.....	Thermoplastic
Orientation.....	Horizontal or Vertical
Connection Type.....	Multi-Flow/ 3" Sch 40

### VALUE