

Standard Profiles

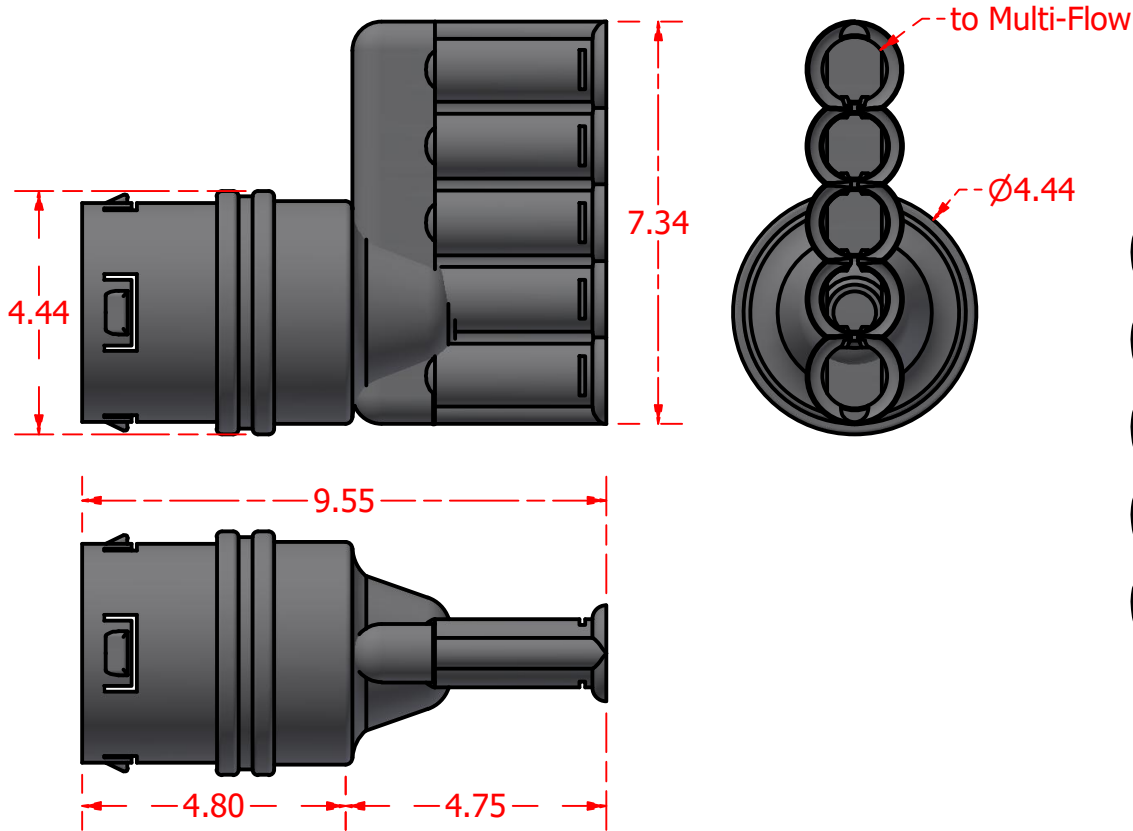

Isometric Views

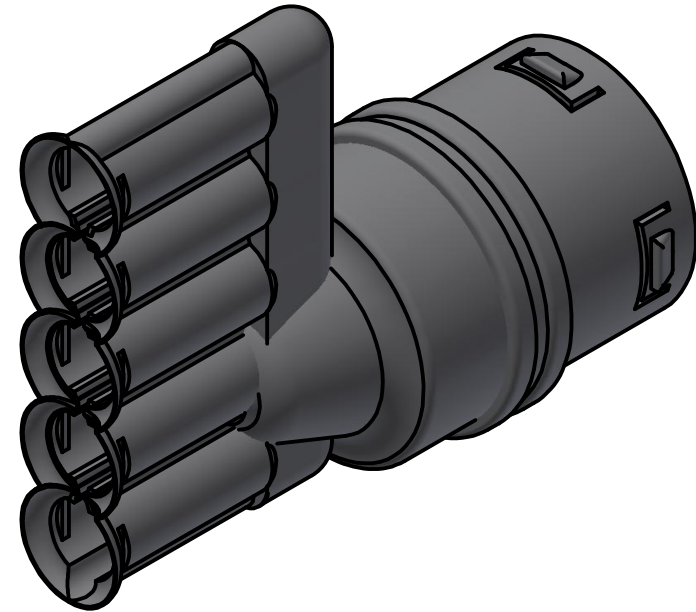

Multi-Flow Product Data Sheet - #06014 6" End Outlet to 4" Corrugated Internal Coupler



Manufactured by Varicore Technologies, Inc. - Prinsburg, MN 56281 - 800.978.8007

The Multi-Flow logo is Copyright protected, all rights reserved.

US Patent Protect - 9483745856834

PROPERTY

Material Composition.....High Density Polyethylene
 Orientation..... Vertical
 Connection Type.....Multi-Flow / 4" Corrugated HDPE

VALUE

